



Manufacturers of High Temperature & High Vacuum Equipment

1017 Bransten Road | Phone (650) 593-1064
 San Carlos, CA 94070 | Fax (650) 593-4458



Specification Sheet

Equipment Model: GVAC-2000 Vacuum Furnace

Type	Coldwall, Vertical, Top Loading/High Vacuum
Maximum Temperature	2000° C.
Hot Zone (Nominal)	3.5" (90mm) Dia. X 7" (180mm) Deep Nominal
Frame Dimensions	51" (130 cm) W. x 26" (66 cm) D. x 20" (51 cm) H.
Power Requirements	240V 1 Ph. 60A 60 Hz. – 230V 1Ph. 60A 50 Hz..
Gas Requirements	25 – 50 psig, Nitrogen (1/4" Swagelok)
Compressed Air	80 – 100 psi (1/4" Swagelok)
Element Style	.010 Tungsten sheet

Process Vacuum at temperature 10⁻⁶ Torr range
 Vacuum in 10⁻⁷ Torr range at ambient

Cooling Requirements - 25 psig at 3 gallons per minute. Note maximum back pressure is 15 psig. (34,000 BTU)

Heat up ramp rate 100° C per minute - empty chamber.

Heating elements and heat shields are constructed of Tungsten & Molybdenum. Insulators are made of High Alumina.

Standard Features:

- 300 LP/S Turbo Pump
- Digital Chart Recorder
- Microprocessor Controls - Ramp & Soak
- 19 Programs - 20 Segments per Program
- Sight glass for calibration melts
- Active Braze Control
- Fully Automatic - One button push starts the run.

Automatically it will:

- Rough Pump
- Cross over to High Vac
- Ramp to Temperature and Soak
- Cooldown
- Backfil to ATM

Options:

- Partial Pressure Operation
- Survey Thermocouple
- Tower Indicating Lights - 3 Color
- Computer Controls
- Positive Pressure Hydrogen Operation
- Residual Gas Analyzer
- Tungsten Mesh Element



Manufacturers of High Temperature & High Vacuum Equipment

1017 Bransten Road | Phone (650) 593-1064
San Carlos, CA 94070 | Fax (650) 593-4458

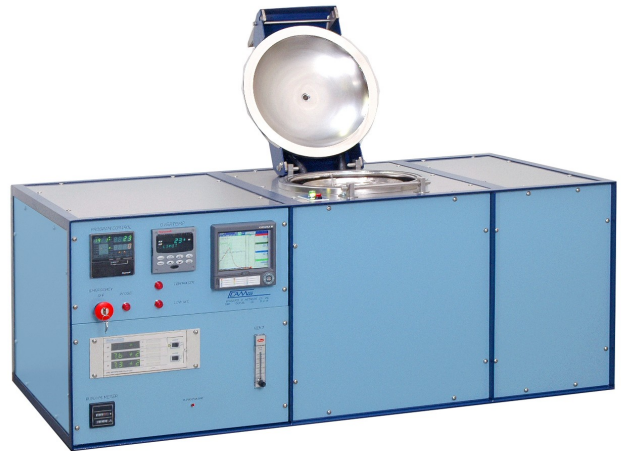

Equipment Description

Model G-VAC-2000

CAMCo 3.5”(90mm) Dia X 7”(180mm) deep 2000° C Top Loading

Tabletop High Vacuum Heat Treating / Brazing Furnace
For Automatic Programmed Operation to 2000° C.

Overview

The Camco Furnace “G-VAC-2000” tabletop high vacuum furnace is designed to reproducibly vacuum braze, degas, sinter and otherwise process loads of up to 3.5 inches by 7 inches deep. The operator selected ramp and soak program is accurately controlled to 2000° C at pressures to the 10^{-6} Torr range. The furnace and vacuum controls, pump system and interlocks, are integrated in a fully automated unit to assure simple reliable operation.

Operation

The work is lowered from the top of the furnace onto a 3” dia tungsten hearth plate, the top heat shield stack inserted, and the door closed and latched. One of nineteen selectable, user programmed pump down and thermal profiles is chosen, and the “Start” key pressed. The high vacuum gate valve opens and the Chamber is roughed out. A direct drive mechanical pump is coupled to the turbo-pump thru a foreline valve and trap. This pump serves as a roughing and foreline pump. This first stage vacuum evacuation is accomplished thru the idle 100 mm turbo-molecular high vacuum pump in approximately three minutes. At its limiting fore-pressure, the turbo-pump is automatically started. It reaches full speed within 4 minutes. As the pressure falls below 1×10^{-3} Torr, the high vacuum ionization gauge is powered. In the clean system, low five-scale mid six-scale pressure is reached in a total time from cold start-up of approximately fifteen minutes. The selected time vs. temperature profile then runs. Upon completion of the cooldown portion of the program, the gate valve closes (if the program does not provide to leave the load under vacuum) the turbo-pump is powered down and the foreline valve closed. The chamber vented to Nitrogen or other inert gas to facilitate un-loading. If desired to facilitate more rapid cooling, the furnace may be programmed to close the gate valve immediately on removal of power, and as the turbo-pump is powered down, inert gas is admitted to a programmed level. The furnace is programmed to remain in this state until the safe access temperature has been reached, at which time the program ends, leaving the load in the inert atmosphere until the operator wishes to continue backfilling to remove the work.

Construction

The cabinet measures approximately 51” wide by 26” deep by 20” high. Its substantial frame is constructed of heavy steel structural shapes. Square tubular support feet provide a convenient location in which to insert bars for lifting. Panels are readily removed to gain access for efficient, on the spot service. A cooling fan draws air thru a disposable filter to cool the power components. The cabinet’s sturdy steel floor supports the furnace power transformer and the mechanical pump. Mounted within this structure also, are the S.C.R. power control, turbo-pump converter, control transformer, logic electronics, interlocks and plumbing. The controls are conveniently located at the left front. The finish used on this, and all CAMCo equipment is baked powder coat paint, chosen for its’ durability and solvent resistance.

Vacuum Chamber Assembly

The double wall, water-cooled stainless steel vacuum chamber, a water-cooled copper pumping port baffle within the chamber, the gate valve, and the turbo-pump are assembled as a module. This is bolted at the chamber flange to the right top panel that supports the chamber assembly within the cabinet. The chamber cylindrical wall is penetrated by the element power feedthru ports, furnace thermocouple fittings, and the vacuum system neck. This neck includes fittings for the ion and convectron gauges, and gas vent port.

Chamber Door Assembly

The double walled, water-cooled stainless steel door is flanged to mate with the chamber. The door handle includes a cam locking arrangement to easily compress the "O" ring door seal. Needle-bearing hinges provide accurate registration of the door to the chamber. A centrally located sight port permits viewing the work thru the viewing holes in the front shield stack. A positive locking solenoid prevents the door assembly from opening until the temperature of the furnace has cooled to the predetermined safe access temperature setpoint.

Heat Shield and Element Assembly

The furnace proper is located within the double wall water-cooled chamber in the center of the frame. It is very conservatively rated for continuous 2000° C operation. The low voltage, .010 tungsten heating element is supported by the 1500 amp water cooled power electrodes. This element is surrounded by 2 tungsten and 6 molybdenum heat shields. Work is placed on a 3" dia Tungsten metal hearth. The top shield stack assembly is removed exposing the 3.5 diameter x 7" deep hot zone. Product is lowered onto the hearth by hand.

Heating Power Supply

Power is delivered by a conservative, continuously rated 10 KVA transformer. This is driven by a digital line and load regulated, phase angled fired SCR control. A current limiting feature is included, which provides long element life.

System and Temperature Control

Temperature control and monitoring functions are achieved using two high temperature type "C" thermocouples. Multi-stage programmed control is achieved through use of a Honeywell DCP302 process controller which receives its' input signal from the thermocouple located in close proximity to the heating element. Automatic time/temperature ramp and soak programmed control of up to nineteen different, 19 segment programs may be stored. The operator is required only to insert the load, specify a program by letter and press the start button to operate the furnace. The process controller, in conjunction with the vacuum gauge control, also provides necessary vacuum system control functions. Load temperature monitoring is provided by a second thermocouple located within close proximity to the load. It drives a Honeywell UDC2500 process monitor, which provides digital readout of the load area temperature and provides an over-temperature shutdown signal. The process monitor also provides a safe chamber access interlock and access signal for the operator.

Atmosphere Control

Our vacuum furnaces can be ordered with Combination Vacuum and Inert Reducing Atmosphere control. Through programming, either vacuum or atmosphere can be chosen to make this an ideal R & D or laboratory furnace. When this option is ordered, the furnace can run either Nitrogen or Argon as the purge gas. The process gas can be Hydrogen, Hydrogen Argon or Hydrogen Nitrogen. A Bubbler to humidify the process gas would come standard with this option. A burn-off column to ignite excess process gas is also standard. As with our standard atmosphere furnaces, this combination furnace comes with all the safety interlocks required with Hydrogen operation.

Safety Features

- Thermocouple break protection (Thermocouple burn-up) assures that heating power is removed from the furnace in the event of sensor failure.
- Overtemperature indication is read on a separate control module from the monitor thermocouple. This overtemp alarm causes the heating elements to shut down as a further backup.

Other numerous interlock functions protecting the operator and equipment include:

- Panel Interlock
- High Cabinet Temperature
- Low Coolant Flow
- Low Gas Pressure Switches
- Vacuum Ramp Delay
- Heaters are interlocked with the vacuum gauge control so that heating will not occur if there is insufficient vacuum.
- Thermal overload protection for the Turbo Molecular Pump
- High Vacuum isolation valve to protect the Turbo Pump during vent and quick cooling of the hot zone.

Digital Chart Recorder

Included in every Camco Furnace is a digital chart recorder for continuous monitoring of thermocouple inputs and other components. Standard inputs include control thermocouple, part thermocouple, over-temperature thermocouple, vacuum levels, and program setpoint. Other inputs that can be monitored (based on options ordered) include additional survey thermocouples, dewpoint monitors, current sensors, vacuum transducers, coolant temperature and oxygen analyzers.

This chart recorder includes 512MB of memory which covers decades of recordings. It is packaged with convenient software for reading files and can be either read from an external memory card or connected to a network and read remotely via FTP.

The recorder also has webserver functionality that runs through the network to show you quickly the current state of the furnace in real time. This feature is especially useful if the furnace is to be installed, for example, in a clean room where access is limited (or a hinderance to physically get to).

Documentation

An operating manual is supplied with the equipment. Blank worksheets included in the manual provide a convenient form for depicting the desired process for entry into the microprocessor controller, and also serve as a hard copy of the program. The unit is shipped with an example program stored in memory, which is depicted by the enclosed example worksheet. Included are a trouble-shooting guide, spare parts list, major component product sheets, manuals and a full equipment description with facilities drawings. Facilities information is supplied prior to shipment to assist in preparation for receipt of the equipment.

REV.	DATE	DESCRIPTION

G-2000

∅3.50 X 7.00 HOTZONE

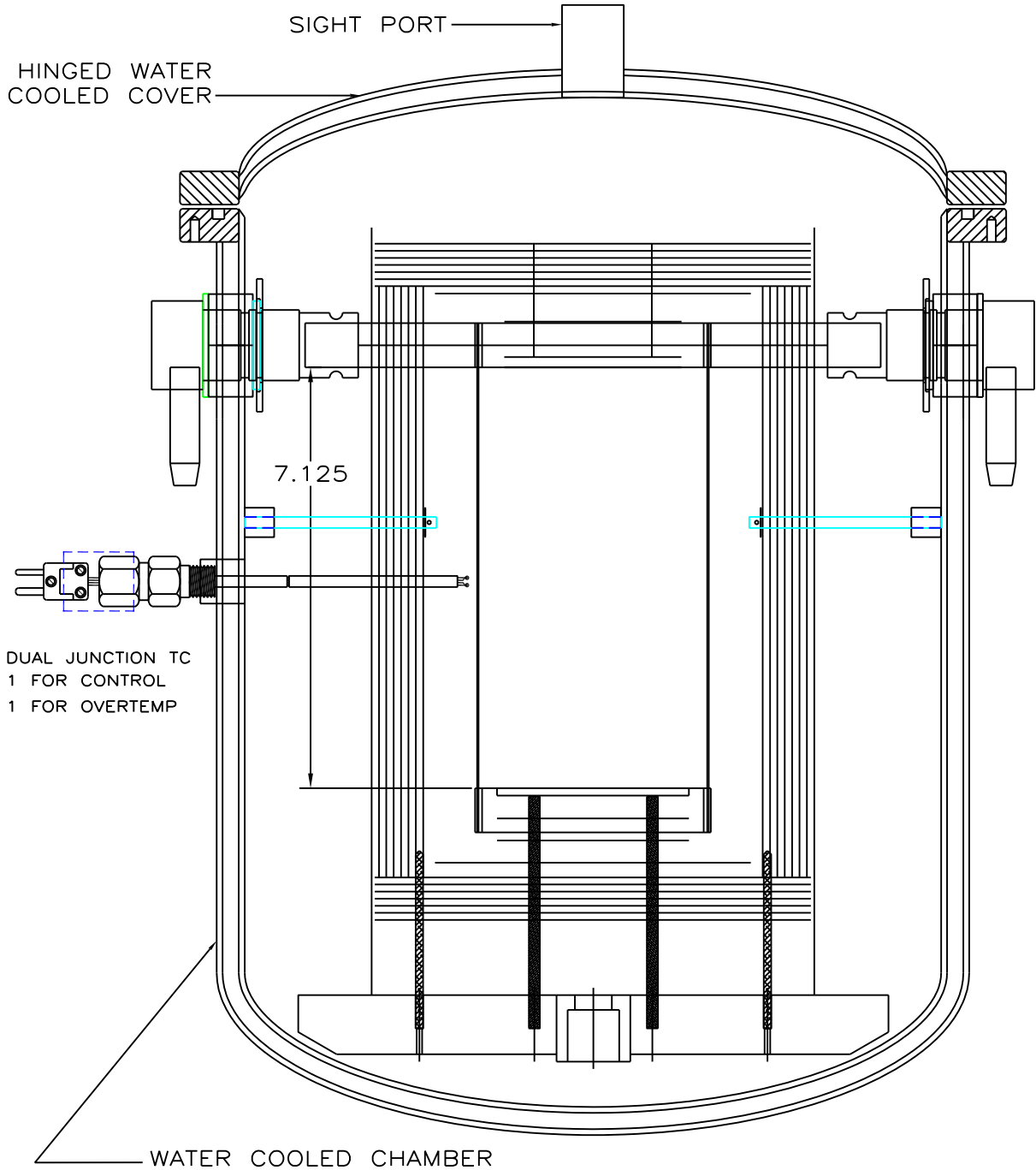

NOTICE: This document contains information which may be confidential and/or tradeseecret and/or proprietary to Concepts & Methods Co. Inc. and its' affiliates. This document is submitted to you in confidence and shall not be reproduced, disclosed to others, or used in manufacture without the express written permission of Concepts & Methods Co. Inc.

		TOL'S EXCPT AS NOTED	DRN.BY: TBARULICH
		fract. ±1/32	APP.BY:
		.XX ±.010	DATE: 5-9-11
		.XXX ±.005	MAT: NOTED
		.XXXX ±.0005	FINISH:
USED ON TASK	FWO	ANGLES ±1/2°	

CAMG
Concepts & Methods Company, Inc.
 TITLE: G-2000 CHAMBER & HOTZONE LAYOUT
 DWG.NO: 89152 | SHEET 3 OF | REV:

REV.	DATE	DESCRIPTION

UTILITIES: PREPARED AS SHOWN BY CUSTOMER.

- A: 60A. @ 208 OR 240V. 60 Hz SINGLE PHASE DISCONNECT.
- B: NITROGEN, 30 TO 50 PSIG AT A MAXIMUM FLOW OF 30 SCFH
- C: DRY FILTERED AIR, 80-100 PSI
- D: COOLING WATER SUPPLY; 25 PSIG MIN. AT 2.5 GPM - SEE NOTE
- E: COOLING WATER RETURN OR PRESS. DRAIN IF USED--SEE NOTE
- F: LINE PRESSURE REGULATOR SET AT 40 PSI.

- 1/4" TUBE
- 1/4" TUBE
- 1/2" FPT*
- 1/2" FPT*

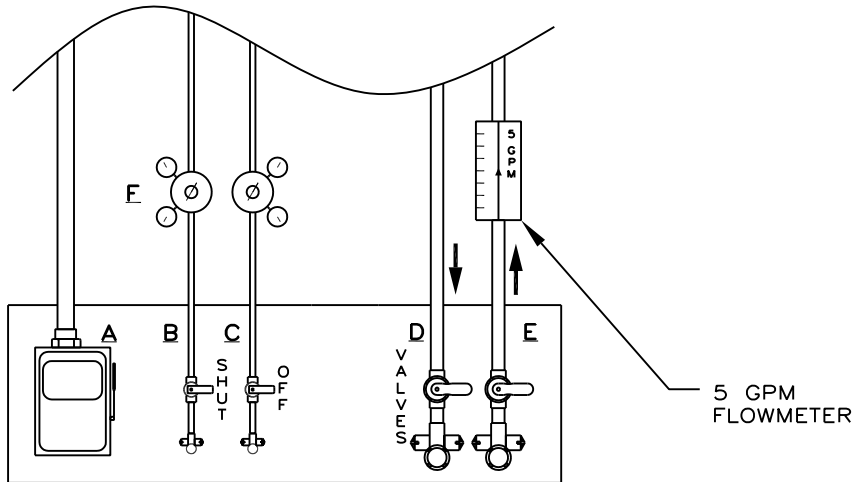

SUGGESTED UTILITY PANEL LAYOUT
LOCATE ON WALL BEHIND TABLE

UTILITY WALL LINE

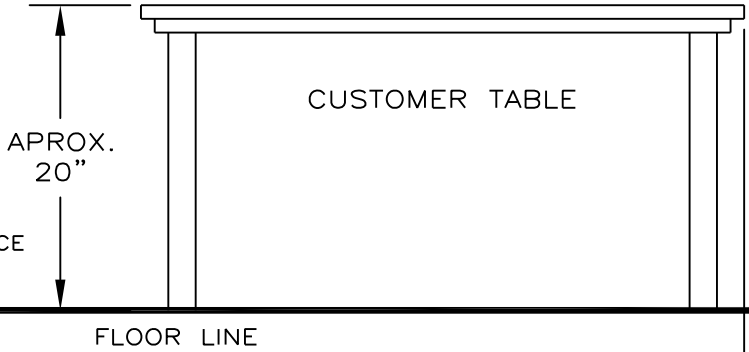

* 6' WATER HOSES SUPPLIED FOR CONNECTION FROM SHUT OFF VALVES TO FLARE FITTING AT REAR OF FURNACE

24.00" SUGGESTED REAR ACCESS (NTS)

NOTE: (MAX. BACK PRESSURE 15 PSIG AT 4 G.P.M.)

NOTICE: This document contains information which may be confidential and/or tradeseecret and/or proprietary to Concepts & Methods Co. Inc. and its' affiliates. This document is submitted to you in confidence and shall not be reproduced, disclosed to others, or used in manufacture without the express written permission of Concepts & Methods Co. Inc.

		TOL'S EXCPT AS NOTED	DRN.BY: T BARULICH		
		fract. ±1/32	APP.BY:		
		.XX ±.010	DATE: 6-12-06	TITLE: G-VAC TOP LOAD FACILITIES PREP.	
G-VAC TOP LOAD	345	.XXX ±.005	MAT:	DWG.NO: 89078	SHEET 1 OF
USED ON TASK	FWO	.XXXX ±.0005	FINISH:	REV:	
		ANGLES ±1/2"			

- A: PROGRAM CONTROL
- B: WORK MONITOR
- C: RECORDER
- D: VACUUM GAUGE CONTROLLER
- E: TURBO CONTROLLER

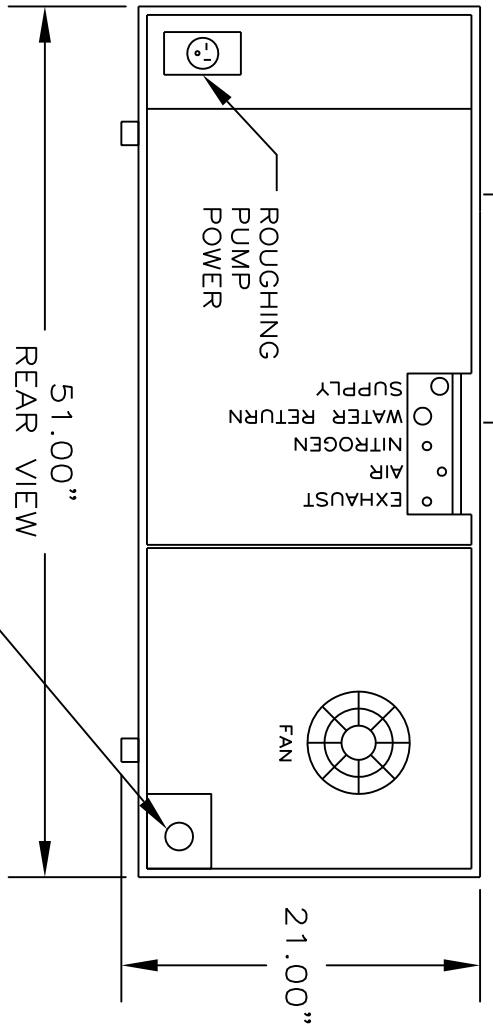
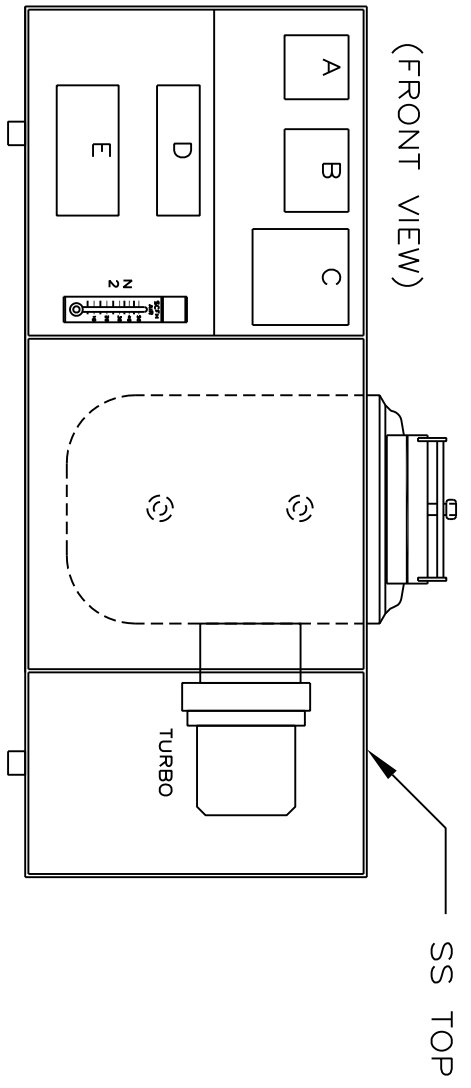
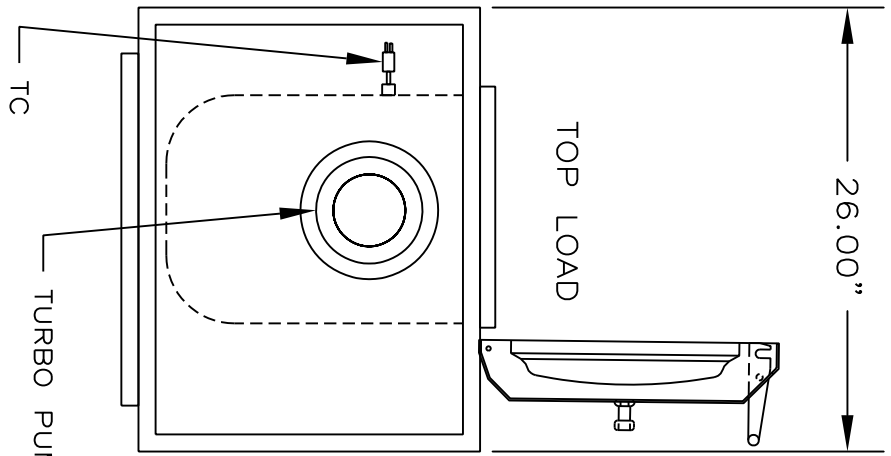

NOTICE: This document contains information which may be confidential and/or proprietary to Concepts & Methods Co. Inc. and its' affiliates. This document is submitted to you in confidence and shall not be reproduced, disclosed to others, or used in manufacture without the express written permission of Concepts & Methods Co. Inc.

G-VAC FURNACE TOP LOAD	FWO
USED ON TASK	

TOL'S EXCPT AS NOTED	DRN. BY: T BARULICH
frcct. ±1/32	APP. BY:
.XX ±.010	DATE: 11/21/07
.XXX ±.005	MAT:
.XXXX ±.0005	FINISH:
ANGLES ±1/2°	

CAWVE
Concepts & Methods Company, Inc.
 TITLE: G-VAC FURNACE FACILITIES PREP.
 DWG. NO: 88509 SHEET 3 OF 8 REV:

REV.	DATE	DESCRIPTION